

ITEM	DWG. NO.	NAME OF PARTS	SIZE	MATERIAL	UNIT	MASS	REMARKS

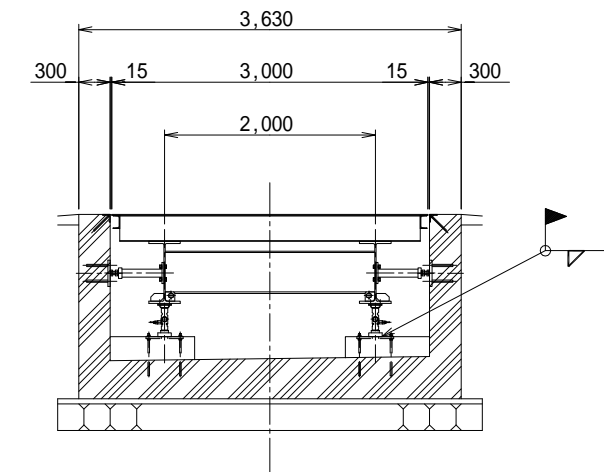
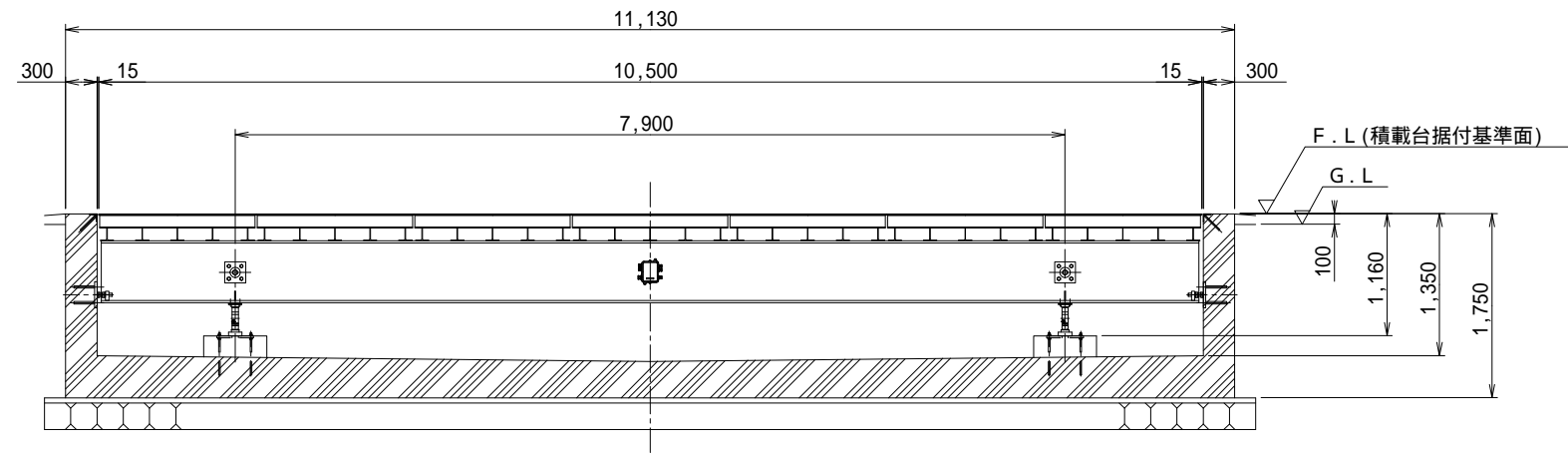
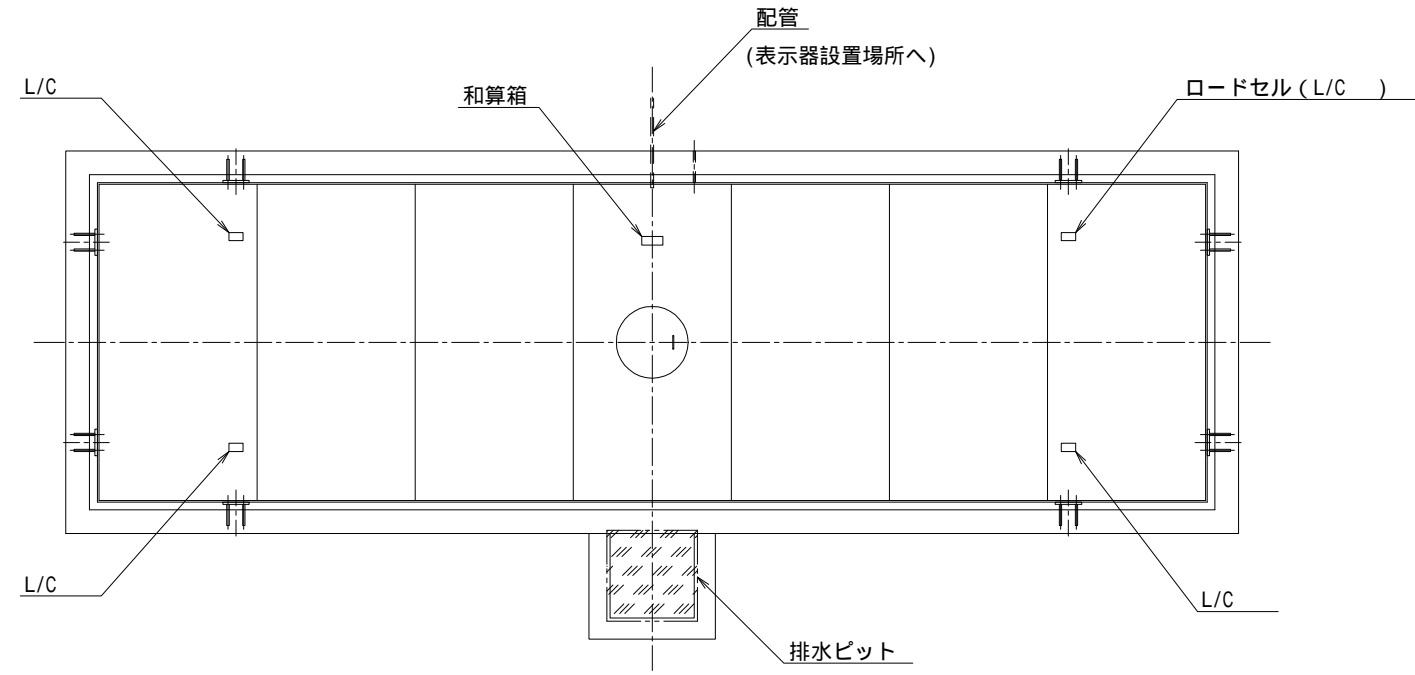

APPROVED	CHECKED	DESIGNED	DRAWN	TITLE
平川	河原	岩本	松浦	KMT 8 - 10530 - 3 トラックスケール
DATE '00.2.24				SCALE 1 : 50
ORIGINAL NO.				JFE Advantech Co., Ltd.
DRAWING NO.				DA 2 - 5537

MARK	REVISION	DATE	REVISED	APPROVED